



5

PRACTICAL SEAMANSHIP

For thousands of years human beings have gone to sea, and out on lakes and rivers - many of them and their vessels or ships have not returned. During the history of seafaring, mariners have made many mistakes and those that survive, learn to change their behaviour. These lessons are translated over the years into traditions. Old mariners pass on these traditions to young mariners.

PRACTICAL SEAMANSHIP

CONTENTS

5.0 Introduction to Practical Seamanship	89
5.0.1 Line Handler	89
5.1 Knots and Lines	90
5.1.1 Construction	90
5.1.2 Lay and Weave	90
5.1.3 Knots, Bends and Hitches	91
5.1.4 Coiling and Stowing	91
5.1.5 General Precautions for Working with Rope	92
5.1.6 Line Inspection	92
5.2 Deck Safety and Lines Under Load	92
5.2.1 Never Stand in the Bight!	93
5.2.2 Watch your head!	93
5.3 Mooring and Securing the Vessel	94
5.3.1 Tying Up	94
5.3.2 Cleat	94
5.3.3 Sampson Post	94
5.4 Anchoring	94
5.4.1 Anchor Types	94
5.4.2 Main parts of a typical anchor	95
5.4.3 Anchor Fittings	95
5.4.4 Setting the Anchor	95
5.4.5 Scope	95
5.4.6 Weighing Anchor	96
5.4.7 Clearing a Fouled Anchor	96

The Footstool that Stopped a Ship

A Canadian Coast Guard ship was responding to a vessel in distress north of Cape Scott in 90-knot winds and 6-9 metre seas. She had been well secured for weather by her crew and was taking forty-degree rolls in the heavy seas. All was going well until a small footstool broke free from its rack in the emergency generator room. It careened around the engine space only to get lodged underneath the protective cover of the emergency generator panel. The leg of the stool hit the only switch that could black out the entire ship. The bridge instruments went out and the helm control died.

The powerless ship swung into the weather and was hit by a huge sea. She rolled onto her side and the bridge crew hung from handles on the consoles waiting for the ship to come back up. While hanging the Captain phoned the engine room and asked when power might be back. The engineers were scrambling to isolate the circuit. As the ship slowly came back up she was slammed by another huge sea. The Captain phoned again and politely said,

“Hi guys, uhh... power would be nice, anytime now.”

The lookout reported another huge sea approaching. At that moment the power flashed on and the Captain dove to the throttles.

The ship met the towering wave bow on.

“Helmsman resume last heading please.”

“Course steady on 330°, Sir.”



5.0 Introduction to Practical Seamanship

A new Canadian Coast Guard Auxiliary crewmember must learn the basic procedures for survival while working at sea. As one starts to spend time on the flat calm water many of the routines seem at first to be redundant and unnecessary. It is not until the vessel and its crew are thrown into a treacherous situation that it will become apparent why these rules exist. If you have not learned to practise safe procedures by then, it may be too late. This basic set of traditions is called seamanship and seamanship training prevents crews from repeating the mistakes of the past.

Most of seamanship can be covered by three fundamental principles:

Order

One of the first doctrines of seamanship is order. In this chapter you will learn that everything on a boat has a place. Things out of their place can cause delays when responding to emergencies and/or can be the cause of a catastrophe in heavy weather situations.

Redundancy

Every critical system on board a rescue vessel should have a backup. All actions and procedures should be checked and double-checked. This routine becomes tedious for new crewmembers that at first think it excessive.

Habit

Each mariner must form habits that happen automatically, habits such as shutting doors, coiling lines and double-checking for loose gear and open hatches. It is not unusual to see a deckhand re-secure a piece of gear three or four times before finally being satisfied with the tie downs.

5.0.1 Line Handler

The linehandler and operational positions will vary with the mission requirements but in general this person performs the functional duties required by the mission. The linehandler will ready and prepare any lines or tackle required for the securing and mooring of the vessel or securing of gear on the vessel. The linehandler will ready and prepare any lines or tackle required in the assistance of another vessel. The operational person will identify hazards on deck or related to the operations (e.g. “don’t stand in the bight!”).

General Duties and Responsibilities of a Line Handler

- ✓ Be responsible for crew and deck safety during line handling operations
- ✓ Verify the plan with the captain/coxswain
- ✓ Inspect all lines and equipment to be used for wear or damage prior to starting operations
- ✓ Secure the decks of all gear and lines for getting underway
- ✓ Coil and stow all line hanging or in lockers
- ✓ Secure lines
- ✓ Check the lead of line to make sure crew are clear of the bight and running gear
- ✓ Keep line clear of running gear, especially in the water (stern and propellers)
- ✓ Continuously report progress of line handling operations and the tension state of lines and any other dangers
- ✓ Ready and toss the heaving line

The only rope on a ship is the one that rings the bell. A rope becomes a line when it assumes a purpose on a vessel. The care and handling of lines is the primary skill of any sailor.



Suggested Commands and Signals for Line Handler

Clear – all crew are clear of lines, gear and machinery that is about to be engaged

Clear Forward Clear Aft – all mooring lines are off the dock and the vessel is clear to proceed

Standby to ... get ready to perform a task

Let go stern, bow, spring or breast lines – untie the line and get it clear of the dock or vessel

Ready Lines stern, bow, spring or breast lines – untie and hold line with on wrap / loop on the rail or cleat and stand by to let go

Ready Lines for port/starboard tie up – break out mooring lines and fenders and rig them for tying up on a designated side

Pass the line – throw the line or hand it to its destination

Make fast – tie up the line

Take a wrap – to control the line without making it fast, wrap it once under the rail or on a cleat and pay out or take in slowly

Slack the line – loosen the line

Pay out / surge the line – feed more line out in a controlled manner



5.1 Knots and Lines

5.1.1 Construction

Natural Fibres

Natural fibres such as manila, sisal, hemp and cotton will shrink when they get wet and also tend to rot or become brittle. Manila is still used today on large ships and is the best natural fibre for mooring lines, anchor lines and as running rigging. Manila has little stretch and is very strong. However, it has only about one-half the strength of a comparable-sized synthetic line.

Natural fibre line should be uncoiled from the inside of a new coil in order to prevent kinks. Always whip the ends of natural fibres to keep them from unravelling. When natural fibre lines have been in salt water you should rinse them in fresh water and allow to dry thoroughly. They should then be properly coiled and stored on grates above deck in a dry, well-ventilated place to help prevent mildew and rot. Natural fibre ropes should be maintained in a clean and dry state, as rot and mildew are their main causes of deterioration. They are, however, more resistant to heat than traditional synthetic fibre ropes; they do not burn quickly and their breakdown is slower.

These lines are rarely used on rescue vessels.



Example of three strand

Synthetic Fibres

Nylon

This synthetic fibre is stronger, more elastic and more durable than manila. However, when placed under excessive load, nylon will break without warning. It is expensive and does not float. Nylon is the best known and most used of the synthetic fibre used in ropes. It has high breaking strength wet or dry and a strong weather resistance. It is highly elastic and when under load can stretch up to 40%.

Nylon ropes are used for shock absorbing when used as mooring lines and are often used to secure fenders to permit stretch as the vessel moves up and down against the dock. Nylon ropes are light to handle and give the appearance of a smooth slippery surface. They have a high melting point (250°C) and are pliable in normal temperatures.



Samson braid line

Polyesters

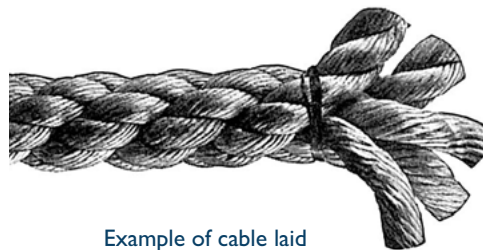

Example of cable laid

Initially known as Dacron® and Terylene®, polyesters are not as strong as nylon and have inferior stretch properties. Their abrasion and temperature resistance are similar to nylon. Polyesters are considered to be more resistant to acids, oils and organic solvents than their nylon counterparts. Their strength remains the same in wet or dry conditions. These characteristics make them ideal for most running rigging of sailboats. The disadvantage of polyester is very similar to that of nylon: it will not float. Its use should be kept to a minimum when working about bits or warping drums. The melting point is between 230 and 250°C.

Polypropylene

This synthetic line is light, flexible and falls between manila and nylon for strength. It's available in bright colours and will float. Floating line stays away from propellers, making it a good choice for a topline and recovery line. However, polypropylene is susceptible to UV damage and will deteriorate over time.

When you see a wet polypropylene rope steaming under tension, it is getting close to reaching the polypropylene's melting point and breaking.

5.1.2 Lay and Weave

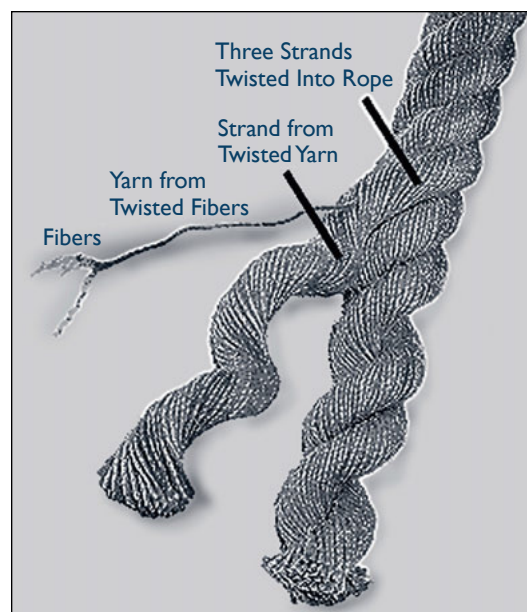

Most line is made from three strands twisted together. The ‘lay of the line’ is the term used to describe the manner in which the line has been twisted. Some of the stronger and more expensive lines are braided together with inner and outer cores. One common line of this type is called Samson Braid.

5.1.3 Knots, Bends and Hitches

Knots have many uses in the maritime world. However, not all knots are equal; some knots are better than others. This section lists various knots that meet the three important conditions for all good knots:

- ➔ Easy to tie
- ➔ Easy to undo
- ➔ Safe (if used as and where recommended)

A crewmember should understand that any fastening (ie. knot) reduces the strength of a rope. Knots and bends reduce the rope strength by up to 50%, while hitches reduce it by 25%. Well-executed splices can be used to join ropes while retaining 80% or more of rope strength. Most knots in polyethylene or polypropylene monofilament ropes tend to slip. These knots must be “doubled-up” in order to hold, due to the waxy monofilament surfaces.

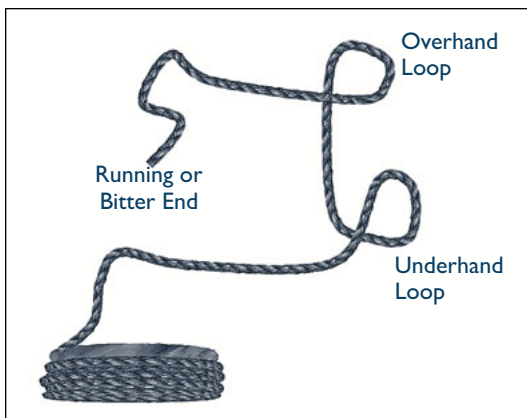

Reef Knot

This knot is good for joining lines of the same thickness together. It can be easily undone. The reef knot is used to fasten two lines of equal size when no great load is anticipated. If used to connect lines of different sizes, it will slip and if used to join two towlines, the knot will jam under heavy stress and be extremely difficult to untie. The reef knot needs constant tension on both lines, for a sharp pull on one of the ends may cause the knot to fall into two half hitches and subsequently binding.

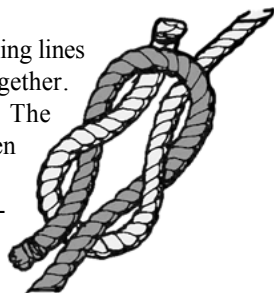

Never use the reef knot to join two lines when significant loads are anticipated. Never rely on this knot when life, limb or valuable property is involved. Severe injury or damage could result from misuse of this knot.

Round Turn and Two Half Hitches

These can be useful to bend the end of a rope to a spar, stanchion, bollard, or ring. To reinforce or strengthen the single half hitch, two half hitches may be used.

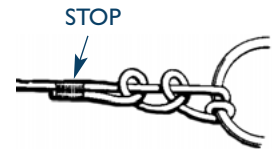

Bowline

One of the most versatile knots, the bowline is good for forming loops in lines with the loop retaining its size. It is a knot that will never slip and rarely jams. The bowline is one of the most valuable knots for day-to-day use on a boat. It is easy to untie after it has been under load. Two bowlines can safely join two towlines of equal or unequal size.



Sheet Bend

A single sheet bend, also known as a becket bend, is used to join lines of unequal thickness. The double sheet bend gives a more secure connection when unequal-sized lines are used, particularly when one line is considerably thicker than the other. This knot is ideal for joining lines together, even if they are of different sizes.

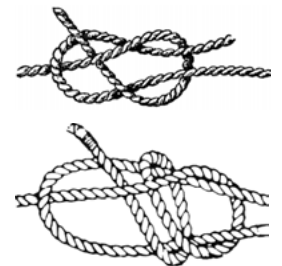

Clove Hitch

This knot is good for making a line fast to a spar or a smaller line fast to a larger rope. It will not slip because the second half hitch rides over the standing part of the rope. The clove hitch is a good choice to use when temporarily securing a line to another rope, a railing, a spar or similar object. It can work loose and should not be left unattended. Under heavy load, it can jam tightly. It can be made more secure with half hitches.

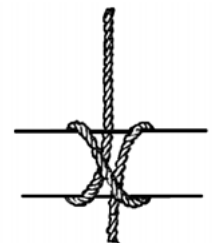

5.1.4 Coiling and Stowing

Lines can become a pile of spaghetti very easily unless one takes the time to handle them correctly. To avoid kinks, twisted ropes should be coiled in a clockwise direction (or in the direction of the lay of the rope) and uncoiled in a counter-clockwise direction. Another method is to flake out the line figure-eight fashion. This method avoids putting twists in the line

Method One

When stowing line away in a locker you can use this method to secure it.



in either direction and minimises the risk of kinking. Braided ropes have no inherent twists and are thus far more resistant to kinking. Even if kinks develop, they cannot develop into knuckles. The best way to prepare braided ropes for deck stowage is with the figure eight method. The rope can be flaked either flat on the deck or figure-eight style, vertically around bulkhead cleats. Hand coiling should be avoided since it will put turns in the rope that are likely to develop into kinks during paying out.

To coil a 3 stand line from a secured end:

- Start at the cleat, with the line in your left hand
- Make smooth, even sweeps with your right hand, and lay the coils (approximately 2 ft. in diameter) one at a time, into your left hand
- If the line is twisted or crossed, spin the line with your thumb to twist the kinks out of it
- Always start from the secured end, or it will end up with twists and kinks
- When stowing lines, make sure the space is flat and even
- When line is coiled, there are two methods used to secure them, see diagrams.

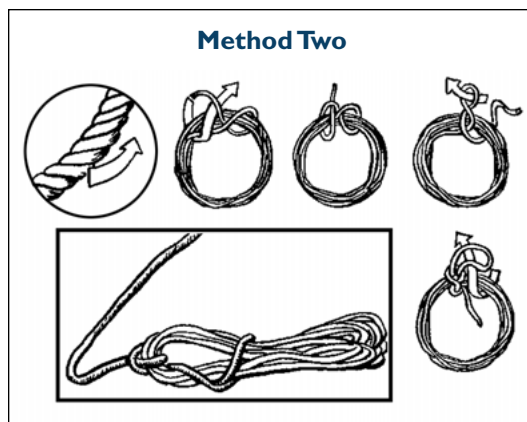

If hanging or stowing the line up for frequent use then a single wrap coil is all that is needed see diagram

5.1.5 General Precautions for Working with Rope

- All rope should be kept dry and clean and away from chemicals, acids, alkali, drying oil, and paint to avoid damage and strength reductions
- Never overload a rope
- A frozen rope should be allowed to thaw and dry before re-use
- A rope should never be dragged over the ground or over sharp objects
- Avoid abrupt bends if possible, as they weaken rope strength considerably. Pad all sharp corners
- Synthetic ropes can be slippery when wet or new

- Store lines in a dry cool place with good ventilation. Hang them in loose coils well above the floor or deck
- Dry and clean wet lines before storing. Allow them to dry naturally, as too much heat will make the fibres brittle
- Keep lines away from all sources of heat
- Lines should be kept out of direct sunlight, when not in use
- Be sure to seal any tail ends of strands by whipping. Artificial fibre ropes can have the cut ends melted, and a heat shrink sleeve shrunk on to the end. Do not use tape for that purpose

5.1.6 Line Inspection

Lines should be checked regularly. The main points to check are external wear and cutting, internal wear between the strands and deterioration of the fibres:

- Check the entire length of the line for breaks on the outside fibres, cuts, burns, signs of abrasion, unlaying and reduction in diameter; each represents a loss of strength
- Untwist the strands carefully to observe internal condition of the line. It should be bright and clean. Excessive wear of interior fibres is often indicated by the accumulation of a powder-like dust
- Pull out a couple of long fibres from the end of the line and try to break them. If they break easily, replace the line
- If a line is found unfit for use, it should be destroyed or cut into short lengths
- If you have any doubt as to whether or not a line is fit for use, replace it immediately

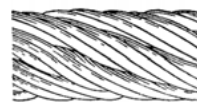
5.2 Deck Safety and Lines Under Load

Lines and wires are of paramount importance in SAR operations. No matter what kind of rescue you are to perform,

in the vast majority of cases, you will have to use one of them at some point in the process. When a line is bearing weight (or is tight), it is said to be "under load". When handled carelessly, loaded lines can kill in the blink of an eye.

Lines or wires that part (break) under strain can kill or injure crewmembers nearby. Especially with artificial fibre ropes, as the line parts, the line will immediately return to its unstretched length, causing it to lash back at high speed. Anyone caught in the path may not survive the experience. By following simple safety rules we can avoid breaking our lines and wires, or at least be out of the way if they do part.

Know the Signs of Overload

When a line or wire is overloaded it will give off warning signs such as:

- Groaning, creaking and popping sounds
- Rotating and stretching
- Shrinking in diameter
- Losing its natural shape
- Strands breaking and peeling
- A steel wire may bleed out the lubrication from the hemp core
- Steam rising from rope

If you suspect that a line is being overloaded then you should take immediate action. Take the load off of the line by communicating with the helmsman to ease the throttle or manoeuvre the vessel to relieve strain, slacking or surging the line if you can approach it and control it safely (see warning).

Do not wear gloves or mitts when working with rope lines. When undoing a line under load, keep your fingers clear of the cleat. When the line comes free it can run quickly, pulling your hand into the cleat or guide. Never stand directly behind a line under load. If it breaks it will whip back and could injure anyone standing in the opposite direction of the load.

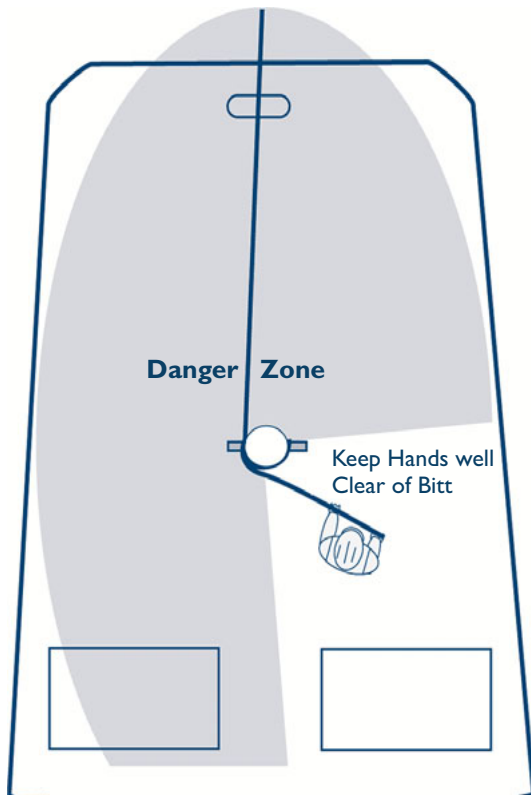

The danger zone highlights the area that is in the direct path of a recoil in case the towline parts.



If a line is showing more than one of the signs of trouble, you should shout a warning and get clear. **DO NOT** try to approach the line to slacken it yourself.

5.2.1 Never Stand in the Bight!

The bight is the loop of a line lying on the deck. If your foot is in the loop when the line tightens, you could easily have your foot cut off or you could be pulled over the side. A bight may not be apparent where the working area is large and where the line may quickly straighten in the event of a cleat, guide or block breaking.



5.2.2 Watch your head!

Never stand under a load, or in areas where overhead equipment may swing and cause serious injury. Always wear a hard-hat, steel toed boots and a PFD when working with overhead loads on board a vessel or at dockside.



Safety equipment is important when dealing with deck safety.

5.3 Mooring and Securing the Vessel

A small boat can have as few as two and as many as eight mooring lines, depending on the weight of the vessel, weather conditions, location and length of stay. If your vessel has a permanent mooring, you may leave the lines on the dock to be picked up when you return.

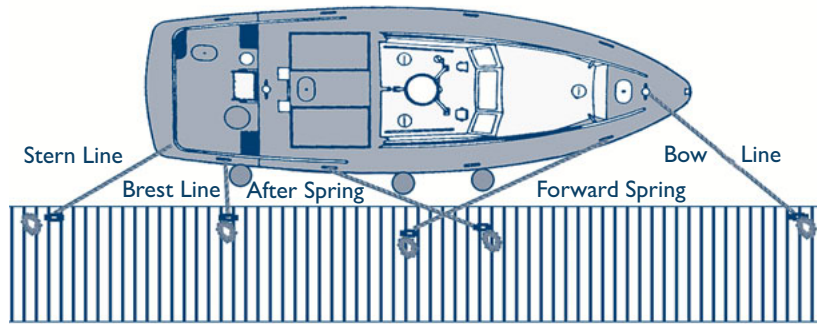

5.3.1 Tying Up



The order by which your boat's lines are to be secured or let go will depend on the preference of the helmsman. He/she may want to use the forward spring to swing the stern out, or the after spring to swing the bow out. The bow line is generally the first on and last off. When tying up at someone else's dock, we can use slip lines on our bow and stern for ease of control. There are many variations to mooring a small boat. The method will depend on the moorings at the dock or facility.

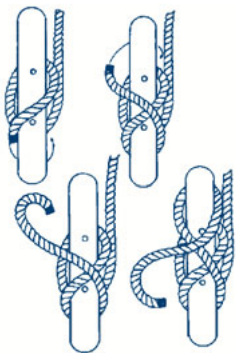

5.3.2 Cleat

The cleat is the most common fitting found on recreational craft. Take a complete round turn around the base of the cleat and lead the line around the horn to form a figure eight. Avoid locking tucks when turning up a cleat, as if it comes under load it will be difficult to undo in a hurry.

5.3.3 Sampson Post

A Sampson post is a special type of deck fitting sometimes used in place of a standard cleat. Begin by making a complete round turn around the base of the Sampson post. Then form several figure eights around the horns. Finish by taking a half hitch around each horn.

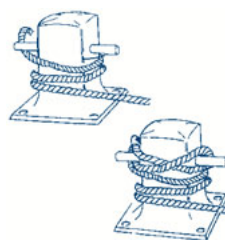

5.4 Anchoring

Small open boats usually use their anchors for a short rest, or to wait out weather or fog. If severe weather threatens, or if you lose power and find yourself drifting into danger, you'll want an anchor that will do the job – grab the bottom and hold on. Many people believe that anchors can hold by their weight alone. Anchors actually hold by digging into the bottom, and therefore the type of anchor you use will depend on the type of bottom you'll be digging into.



5.4.1 Anchor Types

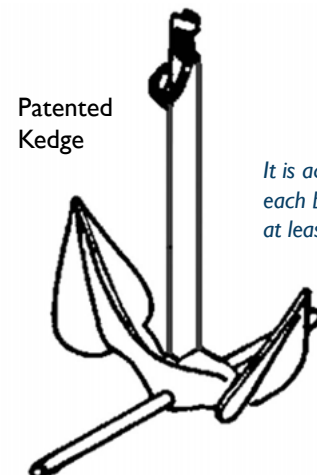
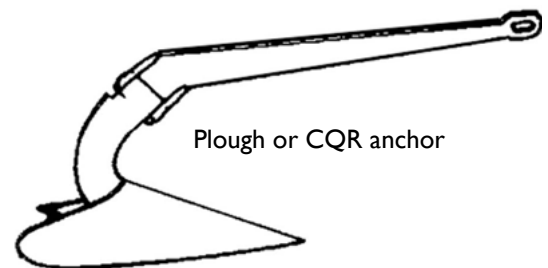

It is advisable for each boat to carry at least two anchors.

There are different types of anchors with specific advantages for each type. The type of anchor and size (weight) of anchor a boat uses depends upon the size of the boat. It is advisable for each boat to carry at least two anchors. The rope or chain that attaches the anchor to the vessel is called the anchor rode.

5.4.2 Main parts of a typical anchor

1. **Shank:** Aids in setting and weighing the anchor. Attachment point for the anchor line.
2. **Flukes:** Dig in the bottom and bury the anchor, providing holding power.
3. **Crown:** Lifts the rear of the flukes, and forces the flukes into the bottom.
4. **Stock:** Prevents the anchor from rolling or rotating.

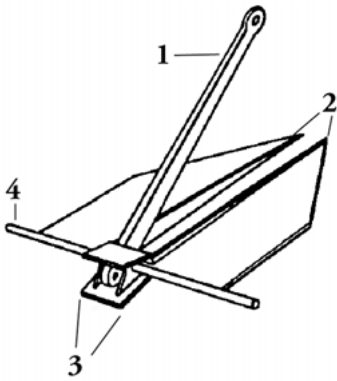

5.4.3 Anchor Fittings

There are various methods for securing the rode to the anchor ring. With fibre line, the preferred practice is to work an eye splice around a thimble and use a shackle to join the thimble and ring.

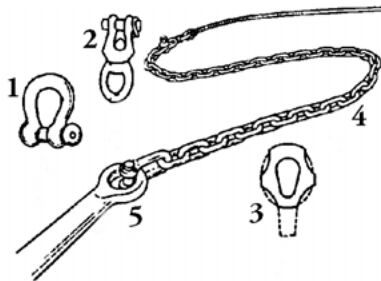

1. **Screw Pin Shackle** – Bends the length of chafing chain to the shank of the anchor.
2. **Swivel** – Attaches the chafing chain to the detachable link. Allows the line to spin freely.
3. **Thimble** – Protects the anchor line from chafing at the connection point. Use synthetic line thimbles for lines 2-3/4" in circumference (7/8" dia

meter) and larger. The **Eye Splice** is used around a thimble to connect it to a ring on the anchor by a shackle.

4. **Chafing Chain** – Tends to lower the angle of pull of the anchor and assists in preventing chafing of the anchor line on the bottom. The minimum recommended length of chain should be equal to boat length.

5.4.4 Setting the Anchor

Five steps to anchoring

1. Fasten the inboard end of the anchor line to a secure point on the vessel, and securely fasten the outboard end of the anchor line to the anchor.
2. Approach your spot slowly, and put your vessel in reverse when you're over the desired location.
3. When the boat begins to gather sternway, lower the anchor to the bottom, and gradually pay out the rode.
4. Take a turn around the bit, snugging up the line, causing the anchor to "bite", then pay out the rest of the rode to the appropriate scope. If there is any doubt, prove the anchor's holding by backing against the rode using reverse power.
5. Finally, check the set of the anchor by choosing 2 objects abeam, which form a range. Periodically check your position in relation to them. Any change in their bearings means that you should try again.

Remember that boats of different sizes may swing to a different scope than yours, so it's important to give other boats as wide a berth as possible

5.4.5 Scope

Scope length is the length of rode required for anchoring, which depends on the depth of the water. The ratio of the length of rode to the vertical distance from the chock to the bottom is called the scope.

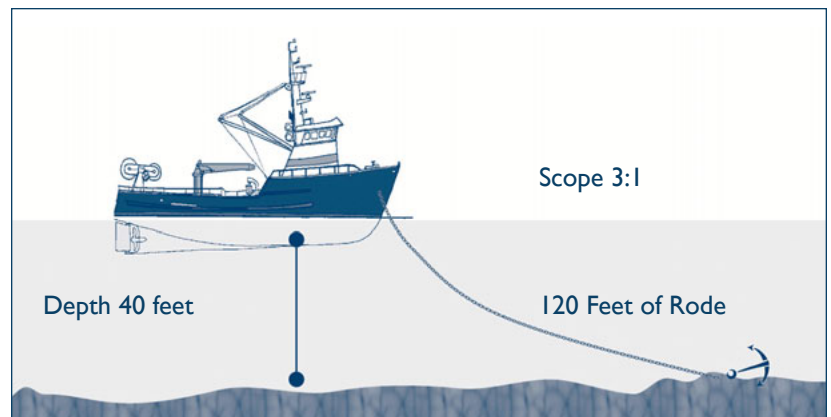

Scope length depends on the type of rode you are using, the weather, and bottom conditions. A scope of 7:1 is ideal in most conditions. For temporary fair weather anchoring a 3:1 ratio will suffice.

To ensure an effective hold, the angle of pull should be kept as close to horizontal as possible. Heavy weather will demand greater scope.

5.4.6 Weighing Anchor

When you are ready to weigh anchor and get underway under power, go forward slowly and take in the anchor rode to prevent fouling the propellers. Have the person on the bow lifting the anchor indicate to the helmsman which direction the rode is leading, so the helmsman can steer in that direction and take the weight off the rode. When the boat approaches the spot directly over the anchor, and the rode is tending straight up and down, the anchor will usually free itself from the bottom.

5.4.7 Clearing a Fouled Anchor

If the anchor refuses to break free, snub the anchor line around the forward bitt or cleat and advance the boat a few feet. Sometimes even this will not free the anchor, and the operator should run in a wide circle, slowly, to change the angle of pull. Take extreme care to ensure the anchor line does not tangle in the propellers during this operation.

Another way to break out an anchor is with a “trip line,” if one was rigged during anchoring. A “trip line” is a line strong enough to stand the pull of a snagged anchor. Attach the “trip line” to the crown of the anchor (some anchors have a hole for this purpose). The “trip line” should be long enough to reach the surface in normal anchoring waters, with allowance for tidal changes. Pass the “trip line” through a float and end the line in a small eye-splice that can be caught with a boat hook. If the anchor doesn't trip in the normal manner, pick up the trip line and haul the anchor up crown first.