

3

VESSEL FITNESS AND SAFETY

“Life Saving Vessels fulfil their function under conditions which, for other craft and equipment, are regarded as extreme – to be avoided, if possible.

Thus the concept of ‘Acceptable risk of failure’ cannot apply.

It is when other vessels have failed that the lifesaving vessel must work.”

*G. Klem, Senior Research Engineer,
Norwegian Ship Research Institute*

VESSELS FITNESS AND SAFETY

CONTENTS

3.0 Introduction to Vessel Fitness & Safety	51
3.1 Briefing	51
3.1.1 Pre-mission Briefing	51
3.1.2 Passenger Briefing	51
3.2 Pre-Departure Check	52
3.2.1 Bring the Weather and Tide Information	54
3.3 Emergencies	54
3.3.1 Crew Overboard	54
3.3.2 Capsize, Sinking	56
3.3.3 Crew Strategies for Cold Water Survival	58
3.3.4 Fire On-Board Your Vessel	58
3.3.5 Signalling a Distress	62
3.4 Vessel Inspection	64
3.4.1 Regular Inspections are Mandatory	64
3.4.2 Example General Weekly Inspection List for Larger CGA Vessels	65
3.5 Vessel Systems Maintenance	65
3.5.1 Inboard Engines	65
3.5.2 Outboard Engines	66
3.5.3 Checking the Electrical System	67
3.6 Fuelling	68
3.6.1 Fuel Consumption and Range	68
3.6.2 Safe Fuelling	68

The Moore family was in distress on board their vessel *Concreta*. Captain Brown took the Rivtow vessel *Lumba Lumba* out into one of the infamous Western Canadian North Coast storms to rescue the stricken vessel. Captain Brown describes the beating that he and his crew took in Keith Kellers' book *Dangerous Waters*.

Excerpts taken from *Dangerous Waters*

Written by Keith Keller

The *Lumba Lumba* was a 90-foot personnel carrier originally built to cross the Strait of Malacca in Indonesia. At approximately one-thirty in the afternoon, with a volunteer crew in place and Brown at the wheel, the *Lumba Lumba* headed into the face of the storm

It was estimated that the *Concreta* was somewhere between Lucy Island and Stephens Island That's where George Moore estimated his position. We had quite a radio system going, with the *Concreta* talking to Bob Pederson ashore on the CB, Bob relaying by phone to our dispatch, who was relaying on to me on the VHF. But it worked really well. Everybody was really cool. I can't say enough about that part. But it was snowing and the wind wasn't easing off and the swell was getting worse, if anything and the Moore family had a dead reckoning position only. Because of the heavy sea we'd had to tone the radar down a bit, which cut out any tar gets, but otherwise you couldn't see anything-the sea was just making a mess of it. Of course we weren't able to pick him up at all

Brown: I tried to go almost straight across the harbour to go through the Metlakatla Pass. The *Lumba Lumba* is a tremendous sea boat, and she laid right over-came very near to standing on her beam ends with the wind velocity and swell. We finally had to run down to the throat of the harbour and then tack back taking it on our quarter, and then through Metlakatla Pass.

Once we got through the pass it was really, really dirty. I would say we had a sea running at that point near thirty feet and winds were definitely gusting up to 80 plus. I think there's comments about 60 and so on, but it would have been around 80, gusting to 85 even. At times we buried the bow, and she had somewhere in the order of twelve feet of freeboard and normally skipped right over most of the swells. She buried her bow under six to eight feet of water, and we had both screws out of the water at times. I had one engine full ahead and one astern at times to keep her head-to.

Somewhere around there the anchor which was lashed forward came loose. And without a thought George Salome, one of the certified masters, went out the side door and forward and the next thing I know he was gone. I thought he was gone completely but the swell wrapped him right around the handrail aft of the starboard wheelhouse door. The handrail saved him from going overboard but he took a beating. It took a couple of fellows to get him unwrapped and secured. We didn't see it until the next day but he was black and blue over his whole body.

He just wasn't thinking for the moment. He'd always been that type of man who responded immediately. We were very very lucky that we didn't lose him. But the anchor was sloshing around, and it weighed a hundred and some pounds and it was bouncing sometimes four and five feet off the deck and he felt, like the rest of us, that it could have come right through the wheelhouse window.

There was a point once we were clear of Metlakatla Pass, two props out of the water, bow buried, anchor loose, one skipper hurt, that I had some doubt about whether we were going to get back. I figured that was the time I'd better ask everybody. I was prepared to go on but I thought I'd better have a show of hands and make sure that everybody else felt the same way. And they did. There was no doubt, no hesitation whatever. So away we went.

We took an awful hammering. At times I went right to my knees. You're hanging on to something and suddenly you don't know how you let go but you did. You just couldn't withstand it, it was such a crashing, crushing kind of thing.



Extreme conditions can test a vessel's limits

3.0 Introduction to Vessel Fitness & Safety

The *Lumba Lumba* continued on and got the Moore family off of the *Concreta* in extremely heavy weather. Both vessels were damaged but Captain Brown knew the limitations of his vessel and crew enough to make the rescue successful.

The only thing separating sailors and the ocean is their vessel. When a rescue crew accepts their pages and begins a shift on call or the auxiliary vessel that you crew is called to action, your vessel had best be fit and ready to handle the worst surprises. It is every crewmember's responsibility to ensure the fitness of the vessel. Only routine inspection and a relentless regimen of care and upkeep can accomplish this job.

It is the Coxswain's/Captain's duty to make sure that the vessel and the crew are prepared to arrive on scene safely, solve or stabilise the incident, and return home. This cycle demands constant diligence from the crew in the practices of inspecting and maintaining the vessel and preparing for on board emergencies. It is a never ending process that starts with the individual crewmember.

Almost every rescue team will encounter situations that require teamwork and positive action to survive. In order to accomplish the goal of assisting people in distress the team and the vessel must be fit and prepared. If something goes wrong the team must be ready to respond with or without direction. This is why we practice.

A rescue vessel can never be too prepared. Caring for a vessel is usually twice as much commitment as originally expected, and the care of a rescue vessel is double that.

Each Rescue Vessel shall be subject to the following constant cycles:

Routine Cycle

- ➔ Regular Inspection
- ➔ Maintenance and Repair
- ➔ Practice for on board emergencies
- ➔ Practice for Transit
- ➔ Practice for SAR

SAR Cycle

- ➔ Alert
- ➔ Pre-departure briefing
- ➔ Crew dons gear and performs personal equipment check (PEC)
- ➔ Crew performs a pre-departure check on vessel
- ➔ Vessel departs
- ➔ Vessel arrives on scene and resolves or stabilises incident
- ➔ Vessel returns home
- ➔ Crew de-briefs
- ➔ After mission: fuelling, damage check, and minor repair if necessary

3.1 Briefing

3.1.1 Pre-mission Briefing

For the crew of the vessel it is important that everyone know the details of the mission and the plan in order to function effectively as a team. In missions such as a search, the Joint Rescue Coordination Centre will have given the coxswain/captain an action plan. It is his or her job to convey the main points of that plan to the crew. Your Coxswain/Captain will give pre-departure briefings. This gives the team a focus and opportunities to develop or modify the plan before you get underway.

The military use the SMEAC model (Situation, Mission, Execution, Any questions, Check understanding); this is a format that extracts the most amount of relevant information and puts it into a form that is easily communicated and remembered.

3.1.2 Passenger Briefing

Each crewmember shall be able to give passengers and new members an orientation to the vessel and a basic safety briefing. There are some fundamental procedures and rules that should be established before anyone goes out on a rescue vessel. Each Auxiliary unit should adapt this list to fit the vessel and the equipment stored on board.



Use the following points to brief the crew

Situation Administration	Mission	Execution Communications
-----------------------------	---------	-----------------------------

Some examples of points

Situation

- Nature of the distress
- Short summary of the history of the report

Vessel:

- Safety / signalling gear on board

Missing persons:

- Gender, height, weight, hair colour
- Colour of clothing: jackets, pants, layers of warmth, hat
- Wearing flotation

Mission

Action Plan:

- General area of mission
- Action to be taken

Execution

Any special instructions from coxswain and division of roles for en-route:

- ETA
- Route to area
- Other units involved
- Action to be taken before arrival

Administration

- Predicted duration of incident
- Relief, if planned
- Fuel stops
- Tide, wind, and weather information
- Equipment and supplies
- Phone numbers and log books

Communication

- Call signs of all units
- Working frequencies
- SITREP times
- Radio checks and cell phone #'s

Example of a Passenger Briefing List

- Location of PFDs and/or lifejackets
- How to put on a PFD and/or lifejacket
- Reminder to passengers that all on board shall wear a PFD and/or lifejacket at all times
- Location of flares and how to use them
- Location of the emergency kit
- Importance of keeping oneself low, on the centre line, and holding onto a rigid part of the vessel while moving around on board
- Importance of keeping one's hands, arms, and legs inside the vessel when approaching or leaving a dock
- Reminder to passengers of the physical effects that they will experience as a result of vessel motion, sunlight, waves, wind, and sound
- Role of each crewmember and/or passenger's role in an emergency

3.2 Pre-Departure Check

If a vessel has been regularly inspected, the pre-departure check will hold no surprises. The principle behind an effective pre-departure check is to test and inspect the critical systems on the vessel before leaving. This check should not take more than a few minutes. Vessel fitness and watertight integrity are things that need to be verified. Major safety and communication systems must be inspected and tested (if practical).

One crewmember or coxswain/captain can read out the list while the others check the equipment. Each item should be verified verbally or written before departure. Any shortfalls shall be reported immediately to the coxswain/captain.

Example Pre-Departure Checklist

- ✓ Verify last regular inspection
- ✓ Attach kill switch to driver
- ✓ PFDs and personal equipment check
- ✓ Tube pressure hull check
- ✓ Fuel / oil levels, tanks pressed up
- ✓ Bilge pump
- ✓ Navigation lights, instrument lights
- ✓ Search lights

**Zodiac Hurricane 8.5 M
CCGA-Pacific**

Sample Equipment Plan

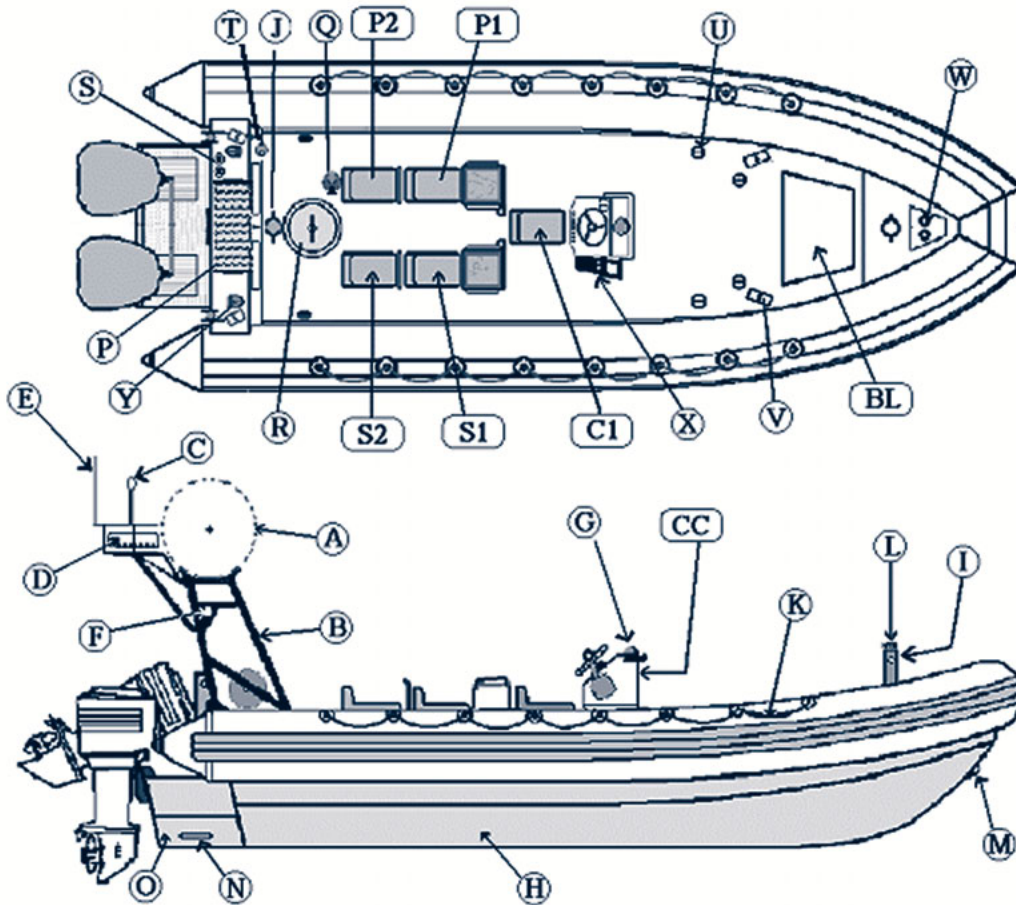

Deck Layout

- BL • Bow Locker*
- Fire Pump Storage
- CC • Command Console*
- Engine Controls & Instruments
- CI • Coxswains Console
- Operators Position
- P1 • Port Fwd. Console*
- Nav & Com Position
- P2 • Port Aft Console*
- Lookout Position
- S1 • Stbd. Fwd Console*
- Nav & Com Position
- S2 • Stbd Aft Console*
- Lookout (Spare)

* • See list for all items stored in Consoles and Boxes

- A • Self Righting Bag
- B • Self Righting Frame
- C • All Around / Anchor Lt
- D • Radar Dome
- E • VHF Antennae*
- * • Not shown GPS, VHF(#2)
- Wind Indicator
- F • Stbd Nav. Light
- G • Magnetic Compass
- H • Aluminium Hull
- I • Fwd. Tow Post

- J • Aft Tow Post
- K • Grab Lines
- L • Bow Lt. Mount
- M • Bow Eye
- N • Zinc's (P & S)
- O • Engine Mounting Box
- P • Tow Rope Reel
- Q • Fire Extinguisher
- R • Deck Hatch
- Auto Bilge Pump
- S • Oil Fillers (P & S)

- T • Manual Bilge Pump
- U • Deck Tie Downs (4)
- V • Lifting Eyes (4)
- W • Fuel Fillers (F & A)
- X • Engine Controls
- Y • Fuel & Aft
- Compartment Vents
- Transom Compartment-
- Fuel Selector Valves
- Fuel Filters, Blower Fan

- ✓ Void spaces or tanks (doors & deck)
- ✓ Self bailing freeing ports/scuppers clear
- ✓ SAR equipment state and stowage
- ✓ Major safety systems (engine space fire system, EPIRBs, GMDSS, life rings, strobes)
- ✓ Navigation systems: radar powered and transmitting, GPS position acquired
- ✓ Engine lines fittings and propellers (steering test)
- ✓ Tools and spares on board

- ✓ Rigging or mast works, antennae and radar tight
- ✓ Self righting equipment connected, pressured, tight, personal recovery line and trigger handle present and ready
- ✓ JRCC notified
- ✓ Radio communications VHF, portables charged and tested
- ✓ Weather & SAR information on board
- ✓ Cellular telephone and extra batteries (if carried)



Kill switch cord must be attached to the kill switch and the helmsman when underway.

CCGA vessel (20-50 feet) Pre-departure Checklist

- ✓ Check fuel levels. Consider free surface effect - keep tanks full
- ✓ Check water tanks. Consider free surface effect - keep levels full
- ✓ Check oil levels. Keep levels full
- ✓ Check filters and ensure they are clean
- ✓ Ensure anchor secured and spurling pipe capped
- ✓ Ensure all hatches are closed and secured
- ✓ Store all ropes and fenders in bow lockers and ensure lockers are locked
- ✓ Ensure life raft is secured and in good condition
- ✓ Check bilges to ensure they are dry
- ✓ Ensure bilge pumps are in good working order
- ✓ Secure all internal lockers and drawers
- ✓ Ensure galley secured
- ✓ Check provisions and replenish as necessary
- ✓ Secure all loose items, include main salon and aft cockpit
- ✓ Check safety equipment and ensure it is in good working order
- ✓ Check all personal safety equipment - strobe, knife, flares, radio
- ✓ Check radios to ensure they are in good order
- ✓ Ensure electronic navigation equipment is in good working order
- ✓ Do a radio check and establish communications with radio station and JRCC
- ✓ Check there are adequate spares on board
- ✓ Check fuel filters, oil filters, impellers
- ✓ Check belts and clips
- ✓ Check tool kit
- ✓ Check pre-cut plywood for window repairs on board and secure



Before your vessel departs, it is important to take time to consider the factors necessary to ensure a safe and productive voyage. Remember that there aren't any second chances.

3.2.1 Bring the Weather and Tide Information

Each rescue vessel should have a designated crewmember that provides the weather forecast and tidal information and brings it on board before departing. This allows the coxswain/captain to prepare the route so as not to put the vessel at risk. You can obtain weather information from radio, newspapers, television, and every meteorological office in the country.

Marine weather forecasts focus on wind direction and strength, precipitation and squall activity, and factors likely to affect visibility, such as haze and fog.

Weather radio Canada, operated by Environment Canada, provides weather information 24 hours/day on VHF/FM radio, as does the Coast Guard on VHF Channel 21B and Channel 83B (try the WX button on the VHF radio). Wind reports heard on the radio will include the following terms:

- ➔ Light Winds (0 - 15 knot winds)
- ➔ Moderate Winds (15 - 19 knot winds)
- ➔ Strong Winds (20 - 33 knot winds)
- ➔ Small Craft Warning (20 - 33 knot winds)
- ➔ Gale Warning (34 - 47 knot winds)
- ➔ Storm Warning (48 - 63 knot winds)

All mariners should learn to read the weather themselves, so that they can detect telltale signs of approaching storms.

Check currents and local hazards

There are danger spots in many areas of our coastal and inland waters. A professional mariner should know where these spots are, and be familiar with how the tides, currents, wind hazards and local outflows will affect them.

3.3 Emergencies

Rescue vessels have specially trained crews because the vessel may find itself in harm's way. On board emergencies are the great equalisers because a small vessel needs all of the crew to respond effectively and skilfully without leadership in the event of an accident aboard the vessel. You may be required to respond without guidance. To accomplish this, you must be trained and practised in the responses to on board emergencies.

3.3.1 Crew Overboard

Recovering a person from the water is one of the most important procedures that a rescue vessel can practice. If the captain is doing his/her job correctly each crew should have practised this manoeuvre many times. It takes preparation and repetition to ensure that your crew is ready to respond in the event of an emergency.

Develop a safe and efficient method for bringing persons into your boat from the water and practice it with your crew.

If a crewmember falls over the side, he or she is facing two immediate dangers:

- ➔ Hypothermia and drowning
- ➔ Not being found

To effectively recover a person from the water, the boat and driver should take the time to Stop, Assess and Plan (SAP) the recovery, without ever losing sight of the person in the water.

Maintain verbal contact with the person in the water. This will enable you to assess the person's level of consciousness as well as to reassure them.

Note: If the operator observes a person falling overboard, alter course to steer the rudder/skegs and propellers away from the person in the water.

Crew Overboard Procedures

1. Shout "Man Overboard!" and throw a buoyant object (buoyant heaving line, throw bag or lifebuoy) to assist the person and to mark the spot.
2. Appoint a spotter to keep sight of the person in the water, and have them point and wave their arm towards the person when they have the victim in sight. If they have momentarily lost sight of the person, they should hold their arm out straight in the direction of the last sighting.
3. Contact Coast Guard Radio on VHF 16 (if available), or contact people on shore. Issue aMAY-DAY if the person isn't recovered immediately.
4. Keep your bow into the predominant conditions (wind current or swell), with the person in the water ahead of you.
5. Stop Assess and Plan when you are 2-3 boat lengths away.
6. Go slowly on final approach. It's better to take your time and succeed the first time, than to have to go around again.
7. Put throttles into neutral when the person is alongside. Do not touch the throttles until the person is onboard or well past and clear of the engines.
8. Use a re-boarding device if necessary. Be careful in retrieval. Persons in distress have pulled many would-be rescuers into the water. Keep your centre of gravity inside of the boat.



sel may have to return to shore and get the crewmember to shelter, depending on the conditions and shelter provided on the vessel.

If there is a possibility of the person in the water suffering from hypothermia, having been immersed for a long period of time, always parbuckle them on board, keep them horizontal, and treat them gently to prevent cold blood from the extremities rushing back to the heart.

Recovering a person from the water is one of the most important procedures that a rescue vessel can practice

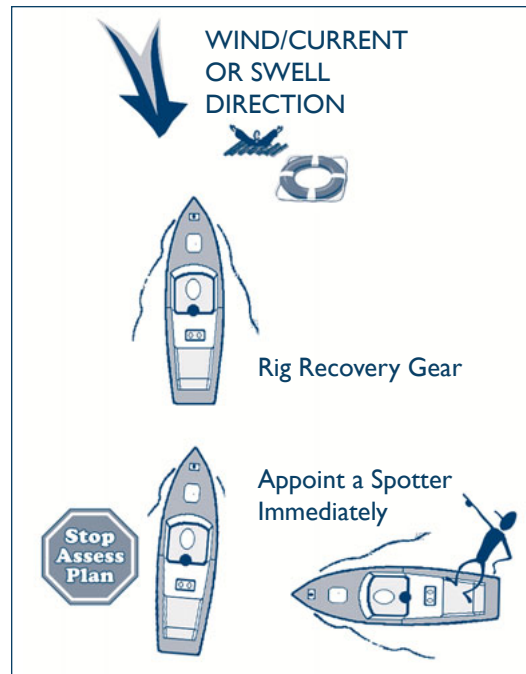

Treating Hypothermia

1. Remove the person from the source of cold exposure, handling the victim gently and keeping them horizontal. Severely hypothermic casualties must be considered stretcher patients, even if they appear to be able to walk.
2. Provide shelter. Once you get the person into a warm environment, remove the victim's wet clothes.
3. Insulate against further heat loss. Cover the victim with blankets or other insulating materials and vapour barrier.
4. Apply warmth to the body core only. Use heat pads or dry, warmed blankets and apply them to the torso, head and neck. Do not give the victim anything by mouth, especially caffeine or alcohol.
5. Be careful of the limbs. A hypothermia victim's arms and legs are full of very cold blood. If the limbs are over-stimulated (e.g. the person is required to move on their own, or the limbs are

Once you have recovered your crewmember, have them lie still while they are checked for spinal or other injuries and signs of hypothermia (if exposed for more than a few minutes). If the crewmember's protective clothing is wet on the inside then the ves-

rubbed or warmed aggressively), this icy blood will be sent to the heart like a bullet. Cardiac arrest will result if the victim's core temperature is low when the cold blood is received from the limbs. Focus re-warming efforts on the body core.

6. Get medical assistance immediately, using or exhibiting distress signals as necessary. Hypothermia is a medical emergency that can present a number of potentially fatal complications.
7. Provide basic life-support as required. If the victim appears to have succumbed to the cold, don't give up. Continue to provide life-support (CPR) until emergency medical personnel arrive.



Recover patient gently using stretcher

3.3.2 Capsize, Sinking

In the event of a capsize, the coxswain must continually assess conditions to ensure the safety of the boat crew and of those in distress. However, all crewmembers must be prepared to perform all the duties involved, for the coxswain/captain may not be able or available to lead.

A boat is less likely to capsize in deep open water.

A boat is less likely to capsize in deep open water. The chances of capsizing are greatest during operations in or near surf or breaking seas. The force needed to capsize is most likely to come from heavy seas directly astern (following seas), or large breakers striking abeam. Stay at sea until conditions change. The safest point for most boats to take heavy seas is nearly bow-on. Vessels should not operate or tow in conditions beyond the capability of the boat or crew

Factors that can cause a vessel to capsize or swamp:

- ➔ Shifts in load (standing up in small boats)
- ➔ Mishandling at high speed
- ➔ Surf or breaking seas
- ➔ Surf or swell in shallow water depth (less than 20 ft.)

- ➔ Heavy steep seas
- ➔ Sudden stops at high speed
- ➔ Overloading
- ➔ High wind
- ➔ Current and tide rips with steep following seas
- ➔ Fast river rapids
- ➔ Loss of stability due to low fuel in the tank, excessive amounts of water in bilges, icing of topsides, or too many people on board

Self-Righting Lifeboats and Rigid Hull Inflatables

Specially designed lifeboats and many sailboats are able to roll through a capsize and right themselves. If you are on board one of these vessels the best action is to hold on tight and do not jump off the vessel. Each self-righting vessel should have a specific set of procedures in place. All crew must be familiar with these procedures and be ready to respond to this situation.

Some Rigid Hull Inflatables are equipped with manually triggered self-righting systems. It may be your responsibility to trigger this system and right the vessel in the absence of a coxswain/captain.

Capsize Reversal Training For 7.3 metre Zodiac RHI as Taught in RHIC School

1. Check crew for injuries and confirm the number of persons on board (POB).
2. All crew to assemble at the transom.
3. First crew member deploys the safety line and swims it out the complete distance (length of line). Remaining crew assist with deployment of safety line, then follow the line out themselves. The coxswain remains at the transom.
4. After the crew are safely out of the way, the coxswain activates the capsize reversal system by pulling firmly on the handle. As soon as the system is activated, the coxswain will swim/pull himself down the safety line and out of the way
5. If the capsize reversal system is operating properly, it should take approximately 7 seconds for the vessel to right itself.
6. After the vessel has righted itself, the crew can begin boarding. Use the windward side of the vessel. Do not try to climb over the engines - it's dangerous!
7. After the crew are onboard:
 - Check your crew for injuries and numbers

- Test your radio
- If no radio contact, activate EPIRB
- Deploy the sea anchor
- Recover the safety line
- Remember that you do have flares, but use them wisely
- In all probability, the engines will have water in the cylinders, & the electrical systems, including the EMM are now, not going to work. Unless it is safe to do so, removing spark plugs, & trying to re-start the engines is not an option to be undertaken. Stay with your vessel, maintain situational awareness, provide first aid (comfort), as necessary, & provide information to rescue services (location, POB)
- PREPARE FOR RESCUE

Emergency Outboard Restart after submersion

(This only works with normally aspirated outboard engines)

In all probability, the engines will have water in the cylinders. Get the water out by removing the spark plugs and turning over the engine until the water is gone. Replace spark plugs and prime fuel lines, then try to start the engines.



Water is expelled from cylinders

Remember: Since the engines will have water in the carbs and cylinders (from the exhaust system), you will have to turn them over for approx. 10-20 seconds. Water will spray out of the spark plug holes. Once the engine is able to turn over without water spraying out, pump the FUEL priming bulb to prime the carbs. **DO NOT PRIME THE OIL SYSTEM.** If the starter is unserviceable, use the pull start method. Remember to activate primer and turn on key when it's time to start the engine. This procedure is taught at the Canadian Coast Guard's RHIOT School.

Recovery after self righting

Once the crew is on board:

- ➔ Check your crew for numbers and injuries
- ➔ Try your radio and send a MAYDAY

- ➔ If no contact, activate the EPIRB
- ➔ Deploy the sea anchor and recover the safety line
- ➔ Remember that you do have flares, but use them wisely

Some Basic Guidelines to Capsize Survival

Increase your chance of escape by planning ahead

If the hull is intact after capsizing, it will not sink for some time, even in rough seas. The crew will have time to escape if panic is avoided. Precautions to be taken ahead of time include:

- ➔ Learn the boat's interior. Initially the crew will be disoriented due to being upside down with inadequate lighting
- ➔ Stow all loose gear and have all equipment and doors operating properly for ease in escaping
- ➔ Know the location and use of all survival equipment. Check it regularly to be sure it is appropriate and in good repair. Be sure that all signaling devices work

Take the time to Stop Assess and Plan, but the crew must make every effort to escape

Don't let go of the boat

If you're not threatened by any danger from surf or rocks, then stay with the boat. An overturned vessel provides a better visual search object than people in the water do, particularly for search aircraft.

In a capsized scenario, the crew should immediately grab onto the hull or lines to ensure the vessel doesn't blow away.

Coaching from outside

If people are trapped under an overturned boat (and still conscious), attempt to have them swim out under their own power. They may have to remove a flotation device to escape an enclosed space. Hold onto a PFD to use as a possible aid in the rescue.

Escape procedures

If trapped in or under the boat, seek out an air pocket near the top (inverted bottom). Gather the crew together in the air pocket and take time to have everyone settle down and focus on planning a safe escape. Discuss the escape route and objects of reference along the route. Look down; light may be visible and escape immediate.

Take the time to Stop Assess and Plan, but the crew must make every effort to escape. The boat may sink, and the air in the space will soon disappear or go bad. Before attempting to escape, check for needed survival equipment, especially flotation and sig-

nalling devices. PFDs may have to be removed temporarily for people to fit through spaces or to go underwater to reach an exit. If necessary, tie a line to the PFD and pull it out after exiting.

Guidelines for escaping from a capsized vessel

- ⇒ Avoid the stern if the engines are still running
- ⇒ If a line is available, the best swimmer should exit first through a cabin door or window, carrying the line
- ⇒ If caught in an open cockpit area, swim down below the gunwales and surface alongside the boat
- ⇒ Locate exit route and reference points from the compartment to open water
- ⇒ Swim underwater through the exit and out from the boat
- ⇒ If no line is available, have the best swimmer go first, followed by a poorer swimmer and lastly a good swimmer (If the poorer swimmers are left alone inside, they are likely to panic and not escape.)
- ⇒ The first swimmer, when free, should signal (e.g. tap on the hull) to indicate success in escape

3.3.3 Crew Strategies for Cold Water Survival

In the event of the rescue vessel being lost the remaining crew can work together to increase their chances of survival. The key actions are conserving energy, preventing heat loss and signalling for help. (See Chapter 2 Personal Safety Section 2.9)

Prevent Heat Loss

- Get on board a life raft if available
- The group should decide who is at the greatest risk and allocate the resources for preventing heat loss with that crewmember
- If a life raft is not available, climb onto the boat, if possible, in order to conserve body heat (heat loss being 25 times greater in water). Otherwise, hold onto the largest floating object available
- Generally, everyone should stay with the boat and not swim for shore. Distances to the beach can be deceiving, and strenuous activities such as swimming in cold water can hasten the onset of hypothermia
- Survivors should consider tying themselves to the boat if there is a rapid means of untying or cutting free, in case the boat shifts or sinks. Most people are likely to become tired or develop hypothermia

- Huddling together in a group with the coldest in the middle prevents excess circulation
- Survivors should keep their spirits up by devising games or routines that keep the groups focused and aware

3.3.4 Fire On-Board Your Vessel

The crew of any vessel must prepare and practice the control and suppression of a fire onboard their own vessel. The key to survival is to save your vessel by suppressing the fire quickly.

Theory: The Fire Tetrahedron

For a fire to occur, four factors must be present:

1. Fuel
2. Heat
3. Oxygen
4. A chain reaction (the chemical reaction between fuel, O₂ and heat)



Remove the Legs of the tetrahedron, any one of these four factors (the four sides of the fire tetrahedron), and the fire is extinguished.

Removal of the fuel source

- ✓ Removal of the fuel source (i.e. wood)
- ✓ Removal of adjacent fuel sources
- ✓ Cut off fuel supply (i.e. liquid gases)

Removal of Oxygen (O₂)

- ✓ Smother flames by the use of CO₂ or foam extinguisher
- ✓ Cut off the O₂ to the fire (i.e. if the fire is in a garbage can, put the lid on the can to cut off the O₂ supply)

Removal of the heat source

- Attack the base of the fire with water to cool and remove the heat source.

Break the chain reaction

- Extinguishing agents like Halon or Dry Chemicals attack the molecular structure of compounds during the chain reaction and reduce the flame-producing capability of the fire.

Most vessels carry small (BI, BII) dry chemical, carbon dioxide, or Halon portable extinguishers, along with buckets, fire axes and in some cases, pumps. This equipment is designed for rapid reaction to and control of relatively small fires at the time of ignition.

Given that most small vessels are constructed using readily flammable material (fibreglass, plastic, wood, etc.) and fuels (gasoline, diesel, propane), response time is critical. The crew of a vessel on fire may be able to extinguish and/or contain the fire before it develops beyond the fire fighting capability of the vessel equipment. The vessel's captain or coxswain must assess a fire situation relative to the crew's ability to cope with it.

Use of Fire Extinguishers

There are four types of extinguishing agents commonly found aboard vessels:

- Water
- Dry chemical powder
- Carbon dioxide
- Halon gas (no longer acceptable in government)

Procedures for Fighting a Fire On board

Find ✓ Find the fire, the location, and its size

Inform ✓ Inform the Captain immediately to sound the general alarm to muster the crew and notify all hands.

✓ Make a distress call to any nearby vessels. Activate emergency fire fighting equipment

Restrict ✓ Restrict the fire. Shut off air supply to the fire – close hatches, ports, etc.

✓ De-energise electrical systems in affected space. Set fire boundaries to confine the fire. Shut off fuel supply and ventilation.

✓ Manoeuvre vessel to minimise the effect of wind on the fire

✓ Prior to activating fixed extinguishing system, ensure that all personnel have been evacuated from the space

Extinguish ✓ Extinguish the fire

- ✓ Determine class of fire, appropriate equipment, extinguishing agent and method of attack

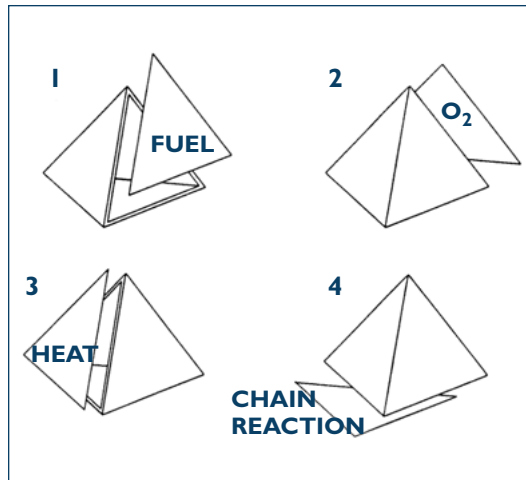

Four ways to put out a fire.

(1) Remove the fuel

(2) remove the air with a smothering agent like CO₂ or foam

(3) remove the heat with water.

(4) or break the chain reaction with dry chemical.

✓ Overhaul and set re-flash watch
Muster crew to account for all personnel

✓ If unable to control fire, prepare to abandon the vessel

Using a fire /Salvage Pump

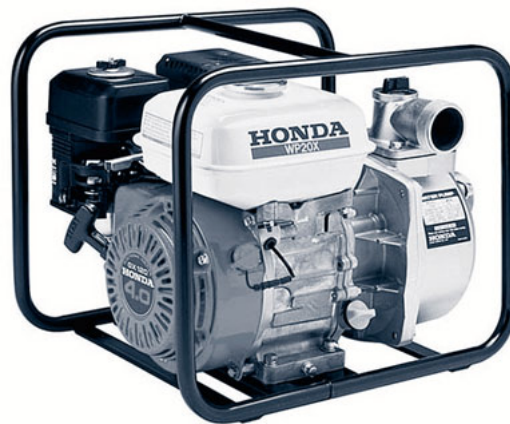

Example Fire/Salvage Pump

The vessel master must assess a fire situation relative to the crew's ability to cope with it.

The portable fire and salvage pump is important equipment when it comes to SAR vessels. The pump is not as readily available or as quickly deployed as the fire extinguisher but this pump may save your vessel and many other vessels if you are practised at using it.

Water

Water is always in plentiful supply in the marine environment. While water is found in portable extinguishers, it is more likely to be applied from buckets or pumps. Water is most effective when used under pressure, in the form of fog. Water applied by

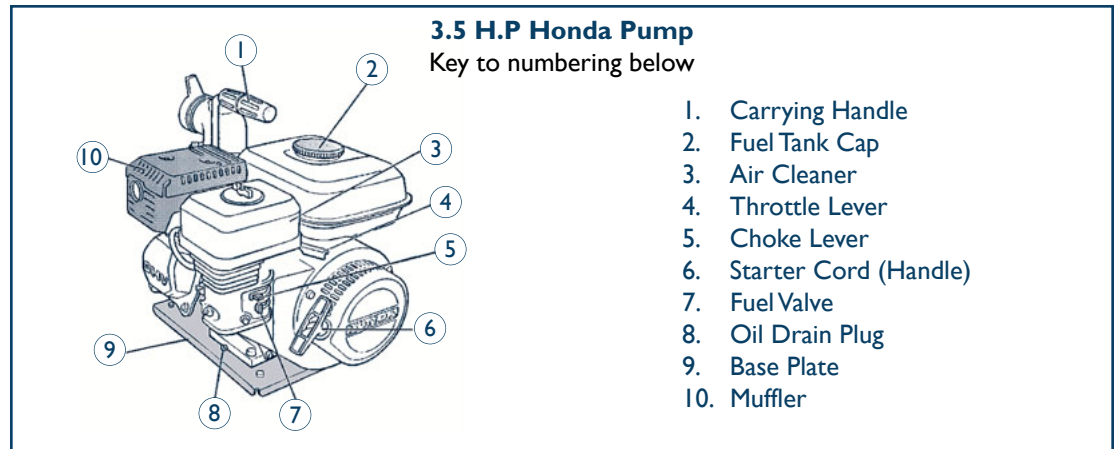

Steps to Starting a Fire Salvage Pump

If you maintain and test the pump regularly then it will start and run when you need it the most.

Set up

- ✓ Place in a spot where the exhaust is clear of flammables
- ✓ Get suction hose and fire hose ready
- ✓ Check fuel

Start

- ✓ Turn on power
- ✓ Adjust choke
- ✓ Open fuel line
- ✓ Set throttle to 3/4
- ✓ Open chamber lid
- ✓ If not a self priming pump, prime chamber (pour water into chamber or fill hose)
- ✓ Attach suction hose
- ✓ Put suction hose over the side
- ✓ Ready output end (control hose nozzle)
- ✓ Pull start cable

Operating

- ✓ Surge the suction hose to help with prime
- ✓ Ease choke until pump runs smoothly
- ✓ Adjust throttle to full
- ✓ Monitor suction
- ✓ Check that exhaust is clear from objects
- ✓ Control water flow with nozzle



bucket or by hose can be used effectively to extinguish burning wood, upholstery, bedding and other combustible solids, excluding fibreglass.

When using water to extinguish a fire aboard a vessel, you must keep the following in mind:

- ➔ Sporadic dousing by bucket will not be effective against major fires
- ➔ Water directed in stream at fuel fires can splash the burning fuel to areas that are not on fire yet
- ➔ Water will turn into steam when placed on a fire, thus further hampering visibility already obscured by smoke
- ➔ Large quantities of water used to fight a fire may affect the stability of the vessel, and thus dictate limited use

Dry Chemical

These extinguishers are given either:

A 'BC' rating for use on combustible liquids (gas, oil, etc.), and on energised electrical fires; or an 'ABC' rating to include all of the above, as well as combustible solids. As with any other extinguisher, the user of a dry chemical extinguisher must read the directions on the extinguisher to ensure its proper use.

Before attacking a fire with a dry chemical extinguisher, the seal should be broken, the safety pin removed, and a short burst triggered to ensure that the device is functioning (a good shake may dislodge any compacted powder). When using a dry chemical extinguisher against a fire, the powder should be directed at the base or source of the flames, using a repeated lateral sweeping motion. Try to avoid breathing the powder if possible. It is not toxic, but can cause breathing difficulty.

If there is a choice of extinguishing agent readily at hand, CO₂ or Halon is preferable to dry chemical powder in situations involving carburated engines and low-voltage energised fires in electronics.

Carbon Dioxide

CO₂ gas is another common extinguishing agent found around small craft. Carbon Dioxide extinguishers are usually either:

The **BI** type, which contain a minimum of 5 lbs. of gas or;

The **BII** type, which contain a minimum of 10 lbs. of gas.

Carbon Dioxide extinguishers are given a ‘**BC**’ rating for use on combustible liquids and on energised low voltage, low amperage electrical fires (Carbon Dioxide gas discharge results in a fog of highly conductive frozen water vapour). Do not use on high voltage or high amperage electrical fires.

Carbon Dioxide suppresses fire by displacing oxygen. When deployed in an enclosed space, CO₂ can cause suffocation. Do not remain in any area where CO₂ has been deployed. As with dry chemical or any other extinguisher, the user must be familiar with the instructions on the device.

Before attacking the fire, trigger a short burst to check that the extinguisher is charged. (The nozzle assembly should never be held after it has been moved into position, as severe frost burn will result.) When using a carbon dioxide extinguisher, the gas should be directed at the base of the fire using the same lateral sweeping motion as with a dry chemical extinguisher.

Carbon Dioxide gas is preferable for use in enclosed spaces where it can be concentrated. It is not effective in exposed situations, particularly if there is a wind blowing. Carbon dioxide can be used to cool surfaces that have exceeded the flash point of combustible liquids, such as in the case of manifolds, turbochargers, and stoves.



Attack fire with low sweeping motion

Fighting fire on an outboard engine

If fire occurs on an outboard engine, in addition to raising the alarm, broadcast a distress message, and steering away from danger:

1. Turn engine off, and back on only to raise out of the water (to prevent drag if tilt motor becomes damaged).
2. Electrically isolate the engine.
3. Turn off the fuel.
4. Use fire extinguishers or dewatering pump to douse flames.

Fires in Engine Spaces

Fires that occur in engine spaces are generally the result of fuel or lubrication oil leaks, or ignited by a backfire, exposed electrical connection, or overheated engine compartment.

Before attempting to extinguish a fire in an engine compartment:

- ✓ Attempt to close fuel supply valves (if accessible)
- ✓ Shut off the electrical current at the battery switch.



Once the fuel and/or ignition source is isolated, attempt to introduce an extinguishing agent into the compartment. This is a dangerous manoeuvre requiring extreme care, as any attempt to open the compartment will introduce more oxygen, which in turn may cause a back flash or explosion. The engine hatch cover should be opened slowly and in such a fashion that, if an explosion does occur, the hatch will not be blown against or into any part of the firefighter's body. It should be opened away from the firefighter.

All of the ‘**BC**’ rated extinguishers can be used effectively on engine space fires. However, gas types (CO₂ and Halon 1211) are preferable; they leave no residue which may compromise chances of repairing and restarting the equipment involved.

Steps to take in the event of an Engine Compartment Fire

- ✓ Shut off all engines, generators, and ventilation systems
- ✓ If boat is equipped with an automatic extinguishing system, ensure it is discharging
- ✓ If the system is manually operated, energize it, and check to ensure it is discharging
- ✓ Initiate a mayday call to alert boats in the area of the situation
- ✓ Have all crewmembers don PFDs and move to a smoke-free and flame-free area of the boat
- ✓ When the captain gives the order, put a life raft or dinghy over the side and ready it for boarding

Opening a hatch

If you must open a hatch to discharge a portable extinguisher, you may get burned. As the fresh air enters the compartment, it will feed the fire and cause it to “blow up.” The best method of opening a hatch is to stand to the hinged side of the hatch. Then, wearing gloves or using something other than bare hands, pull the hatch open. If the boat has a closed engine compartment and no fixed system, it is a good idea to make a small hole with a pivoted cover into the

Classes of Fires and Extinguishing Agents

Class of Fire	Fuel Source	Extinguishing Agent	Primary Effect
A	Fires involving common combustible materials. Fuel sources within this class include wood and wood-based materials; cloth; paper; rubber and certain plastics.	Water	Removes the heat element
B	Fires involving flammable or combustible liquids, flammable gases, greases and similar products. Fuel sources within this class include petroleum products.	Foam AFFF (Aqueous Film-Forming Foam) CO₂ (Carbon Dioxide) Dry Chemical Halon	Removes the oxygen element Removes O₂ Breaks chain reaction Breaks chain reaction
C	Fires involving energised electrical equipment, conductors or appliances.	CO₂ (Carbon Dioxide) Dry Chemical (PKP) Halon	Removes the oxygen element Removes O₂ Breaks chain reaction
D	Fires involving combustible metals. Fuel sources within this class include: Sodium; Potassium; Magnesium and Titanium.	Water (high velocity fog) Sand	Removes the heat and oxygen elements

space. A portable extinguisher may be discharged through this hole.

3.3.5 Signalling a Distress

If your situation becomes serious, the coxswain/captain may decide to issue a distress. This is a decision that should always be made by the coxswain or captain unless they are physically unable to issue the order. Once the order is given, it may be your job to issue that distress. There are many ways to do this and you should know them all. Use any and all available means to call for help.

Communication of distress

Electronic signalling of a distress can be done in many ways (See Chapter 4 Communications Section 4.5 Distress Communications). The main VHF, handheld VHF radios or cellular phones offer the best chance of quick response. The EPIRB may take up to an hour for the distress to be received by a Coast Guard radio station.

Visual Distress Signals

Pyrotechnics or Flares

The purpose of distress signalling is to first attract attention and second, to provide a homing signal to

guide the responding vessel to your craft. The most effective distress signals for attracting attention are aerial flares and parachute flares because they are moving, spectacular, and cover a large sighting area. Once help is on the way, handheld red signal flares, orange smoke signals and orange distress flags serve as beacons helping rescuers to pinpoint your position and keep them on course.

Types of Flares



Type A – Parachute flares



Type B – Multi Star Rocket Flares



Type C – Hand held Flares



Type D – Smoke Flares



Type A, C, and D pyrotechnics are SOLAS approved and have a much longer duration of visibility. CGA recommends use of these types of flares on its vessels. Aerial signals – A SOLAS parachute flare will last for at least 45 seconds.

Aerial Signals

Aerial flares should be fired after sighting or hearing a potential rescue vessel. To attract attention to your distress situation it is recommended that you fire two aerial flares, one immediately after the other, so rescuers can confirm the sighting and the direction of the signal. Parachute flares do not need to be fired in twos since a single parachute flare has adequate burn time (25 to 30 seconds) to confirm sighting and position.

Hand-Held Signals

Hand-held signal flares are intended as homing signals to pinpoint your position. Surface to surface sighting range on water is approximately 3 to 5 miles, depending on boat elevation. If a rescuer is 5 miles away and running at 20 miles per hour, it will take 15 minutes to reach you. Therefore, you should have at least 12 minutes (total burn time) of signals on board to maintain a strong homing signal until help arrives.



When to Signal

Remember, search and rescue missions often establish grid search patterns, which means you may see the same aircraft two to three times coming from different directions. Do not waste aerial flares if the aircraft has initially passed by you. Carrying extra pyrotechnic signals will improve your chances of being sighted.

Four Rules of Signalling

1. Conserve your signals until you are reasonably sure of being sighted. Wait until you see or hear a vessel or aircraft before using “one-time” signals.
2. Stay with the boat if it is safe to do so. A boat is easier to spot than a swimmer.
3. Coast Guard approved marine signals improve your chances, but anything that works is good. Shout, flash your running lights, wave a piece of clothing, use your windshield as a mirror, flash a flashlight, use anything that’s available to attract attention.

4. Familiarise yourself with your signals before you leave shore. Time is important in any emergency and shouldn’t be spent reading instructions.

Smoke

Smoke flares emit orange smoke for at least three minutes. They are excellent daytime signals and allow vessels to track your position over time. Smoke can be any other colour, caused by intentional fire or otherwise.



Strobe Lights

White strobes are a recognised personal inshore distress signal in Canada, but are also used as an anti-collision device by many fishing vessels offshore.



Lamps/Heligraph (Mirror) Reflections

SOS signals (three short – three long – three short flashes).

Dye Marker

Bright orange dye in sea adjacent to vessel or person in the water. These work well for aircraft in daytime.

Arm Wave

Prescribed signal is arms extended from sides, then raised and lowered slowly.

Audible Distress Signals

Loud noises can be made at distinct intervals, such as Morse Code, SOS, or continuously.

Collision Regulations

You should memorise all of the distress signals listed in the collision regulations (Annex IV) before you ever find yourself in trouble.

Distress Signals

Taken From Annex IV (Collision Regulations)

- ⇒ A gun or other explosive device fired at intervals of about a minute
- ⇒ A continuous sounding with any fog signalling apparatus
- ⇒ Rockets or shells, throwing red stars fired one at a time at short intervals
- ⇒ A signal made by radiotelegraphy or by any other signalling method consisting of the group ... _ _ _ _ ... (SOS) in the Morse Code

Stay with the boat if it is safe to do so

- ⇒ A signal sent by radiotelephony consisting of the spoken word “Mayday”
- ⇒ The International Code Signal of distress indicated by N.C
- ⇒ A signal consisting of a square flag having above or below it a ball or anything resembling a ball
- ⇒ Flames on the vessel (as from a burning tar or oil barrel, etc.)
- ⇒ A rocket parachute flare or hand held flare showing a red light
- ⇒ Smoke signals giving off orange-coloured smoke
- ⇒ Slowly and repeatedly raising and lowering outstretched arms to each side
- ⇒ The radiotelegraph alarm signal
- ⇒ Signals transmitted by emergency position-indicating radio beacons (EPIRBs)
- ⇒ Approved signals transmitted by radio communication systems, including survival craft radar transponders

Aviation-Oriented Distress Signals

A piece of orange canvas with either a black square and circle or other symbols appropriate for identification from the air. As mentioned before, a dye marker deployed in the water is easily seen from above.

Canadian Modifications:

- a) A square shape or anything resembling a square shape
- b) A high-intensity white light flashing at regular intervals of 50 to 70 times a minute

3.4 Vessel Inspection

Your auxiliary vessel keeps you alive during an incident. The crew and vessel may be asked to endure extreme conditions and perform extraordinary tasks in the course of their duties. If the vessel is not ready



then the crew is at risk as soon as the key is turned. You, the crewmember and the coxswain/captain are responsible for keeping that vessel ready. Regular inspections are an essential component to a search and rescue unit's routine. The crew must share responsibility in the state of the vessel. Boats need constant attention and upkeep. Special attention should be given to any shortfalls in the vessel fitness and safety equipment.

With basic maintenance and a regular tune-up, a car will run for years. But a boat needs constant attention if it's to remain shipshape. A boat that's being neglected will start to show signs almost immediately, and if the problems are ignored, it can become dangerous.

Vessel Husbandry

When you see a clean and tidy boat that is well equipped and running smoothly, it's usually because someone takes pride in its upkeep. Vessel Husbandry is the caring and conscientious maintenance of a vessel.



3.4.1 Regular Inspections are Mandatory

Each CCGA Vessel will have its own inspection routine. It is the crew's responsibility to find out what the routine is and participate. A daily inspection routine is ideal but not always feasible with volunteer run vessels. Each crew must be confident that the CCGA vessel they operate has been inspected recently and is fully operational. If there are any vessel shortfalls then each crewmember must be aware of those before departure.

Regular inspection is a necessary part of a rescue crew's routine. Each crew must inspect the vessel when they start an on-call shift or before the start of a scheduled voyage. A rescue crew should never be operating a vessel that has not been recently inspected by that crew. The coxswain/captain should be involved in this routine so they may be aware of the location and status of all gear and equipment.

Each vessel will have its own sheet to use during the inspection. Here are some examples to use as guides for the development of your inspection routine:

3.4.2 Example General Weekly Inspection List for Larger CGA Vessels

General	Safety	Engines
<ul style="list-style-type: none"> ✓ Hull and superstructure ✓ Lines/fittings/rails ✓ Mast and equipment ✓ Mountings ✓ Anchor and Windlass ✓ Moorings ✓ Anchor locker ✓ Lazarette ✓ Void spaces 	<ul style="list-style-type: none"> ✓ Life Jackets ✓ Fire extinguishers ✓ Flares ✓ Anchor & line ✓ Flash lights ✓ EPIRB ✓ Life rafts/life rings ✓ Fire Pump ✓ Sea anchor ✓ Heaving line ✓ First aid bag/stretcher 	<ul style="list-style-type: none"> ✓ Water level ✓ External leaks ✓ Transmission oil ✓ Fuel level sound/gauge ✓ Oil level ✓ Bilges, through hulls ✓ Generator levels ✓ Spare fluids ✓ Belt tension ✓ Run up/in gear ✓ Running gear and steering ✓ Pumps and lines ✓ Rudders
<p>Lights</p> <ul style="list-style-type: none"> ✓ Running lights ✓ Search lights fixed ✓ Search lights portable ✓ Navigation lights ✓ Instrument lights ✓ SAR Horn ✓ Loud hailer 	<p>Electronics</p> <ul style="list-style-type: none"> ✓ Shore power ✓ GPS ✓ Radar/direction finder ✓ Radios/cell phone ✓ Depth sounder ✓ Single side band ✓ Engine hours 	

Your auxiliary vessel keeps you alive during an incident.



Gas vapours are highly explosive, so the smell of gas fumes should always trigger caution

3.5 Vessel Systems Maintenance

3.5.1 Inboard Engines

With inboard engines come engine and machinery spaces. These spaces, along with the machines they house, require regular maintenance and upkeep. The area should be kept tidy. Any loose parts or tools can cause a fire, or a breakdown in rough weather. If you're operating a vessel with inboard drives, you will have to check this space before start-up.

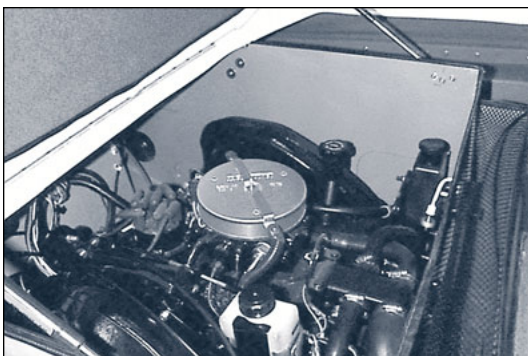

The inboard engine requires special care where the propeller shaft passes through the hull (stuffing box). The stuffing box is a vulnerable spot for damage, and a loss of lubrication or cooling here can become a serious problem.

Fuel Systems

Gas vapours are highly explosive, so the smell of gas fumes should always trigger caution when working with these engines. The blower should be run for a few minutes before starting up, and the engine's fuel lines should be checked visually each day. A vapour detector will help you prevent most gas explosions.

Water Contamination

Any marine fuel system is prone to water contamination, and should be equipped with in-line filters and water separators. If there is water in the separator cups, then consult your manual for the appropriate water decontamination procedure.

Diesel

A diesel system experiences many different contaminants and therefore the filters should be checked and changed regularly. Consult your manual for the appropriate procedures required to clean the fuel system filters.

Ignition System

A clean spark is required for a smooth running gasoline engine. The distributor, points and plug leads should be inspected and cleaned once a month. Dirty spark plugs may cause rough-running engines or engine vibration. Spark plugs should be replaced in accordance with the manufacturer's recommended schedule.

Lubrication

Clean oil means longer engine life. Your oil should be checked daily, and changed on a regular basis. Oil filters should be replaced each time the oil is changed.

Open Cooling System

The hull intakes (if a raw water system) should be checked for obstructions. The pipes should be visually checked for leaks or corrosion. Wet exhaust ports can be inspected for adequate circulation.

If the system is not circulating, it is usually the result of an air lock or obstructed intake. If that isn't the problem, then consult the manual.

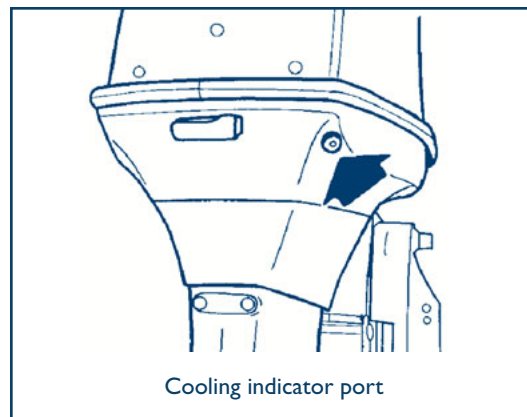

Closed Cooling System

Most inboards are water-cooled systems that need to be periodically flushed and topped up. Closed cooling systems have a heat-exchanger which acts like a radiator does on a car. All of the links in the system should be checked regularly. If the vessel has a fresh water, closed system, then antifreeze levels can be checked when the water is changed.

3.5.2 Outboard Engines

An outboard power plant provides efficient and reliable propulsion. It can be detached and replaced in minutes, or taken in to the shop for repairs. But outboards still need care and attention to remain reliable. They usually operate on one to six cylinders.

Maintenance

Outboard motors should be cared for year-round, and maintained to cope with the changing seasons and use in different operating environments. Here's a maintenance routine that you can follow when checking your motor. Outboards have the same basic needs as inboard engines:

- ➔ Fuel
- ➔ Lubrication
- ➔ Ignition
- ➔ Cooling
- ➔ Cleaning

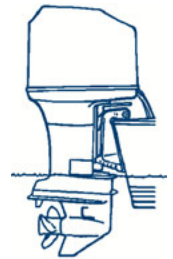

Fuel

Engines that are more modern have an oil injection system that actually mixes the oil at the carburetor. This oil is supplied from a separate reservoir, and is directly injected by a variable ratio pump. When you're at the fuel dock, take time to top up the oil reservoir.

Mixed or straight gas must be filtered for contaminants and water. Sometimes the engine's filter will quickly fill with water, making the system run roughly or stall. A separate water filter system installed outside the engine can eliminate any water problems. These filters should be checked and replaced as per manufacturers recommendations.

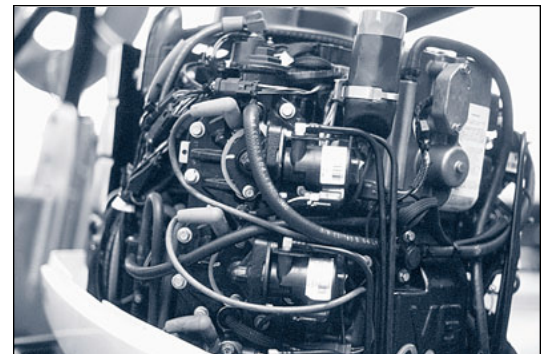

Lubrication

Two-cycle oil lubricates the cylinders directly, since it's mixed with the fuel. It is critical that the oil used is the grade recommended by the manufacturers' specifications.

When you're at the fuel dock, take time to top up the oil reservoir

Outboard Engine Trouble-Shooting Guide

Some Common problems to Check

Motor won't start

- ✓ Fuel supply
- ✓ Fuel line connected, fuel filters and/or screens clear, spark plug wires firmly connected
- ✓ Throttle position (neutral position for starting)
- ✓ Kill switch off

Motor hard to start

- ✓ Out of gas
- ✓ Fuel tank vent is closed
- ✓ Fuel line pinched
- ✓ Fuel line primed
- ✓ Choke malfunction
- ✓ Water or dirt in fuel
- ✓ Loose spark plug wire
- ✓ Dirty or improperly gapped plug tune-up required

Motor runs rough

- ✓ Water or dirt in fuel
- ✓ Carburetor idle, needle needs adjustment
- ✓ Spark plug problems (hard to start)

Loss of power

- ✓ Propeller fouled
- ✓ Not in gear
- ✓ Sheer pin broken
- ✓ Spun prop hub

Vibration

- ✓ Loose mounting clamps
- ✓ Bent propeller

Motor stops

- ✓ Fuel supply
- ✓ No oil in fuel (for 2 stroke engines)
- ✓ Loose spark plug wire
- ✓ Water intake blocked or poor water pump
- ✓ Kill Switch

3.5.3 Checking the Electrical System

The use of electronic devices in the marine environment presents a real maintenance challenge. Electrical connections need constant attention or they will corrode, causing faults and shorts.

Most small craft electrical systems are not complex. They consist of a battery, an engine charging system, and the battery's grounded power support. The engine's ignition system is completely separate from the battery system (outboard only).

Trouble-Shooting your Electrical System

Most electrical problems result from three things:

- ➔ Loose fittings (or broken connections)
- ➔ Corrosion
- ➔ Low battery voltage

Regular inspections of the system and its connections will prevent these problems. All connections should be protected with a corrosion-resistant coating.

Battery Care and maintenance

The lead acid wet cell battery is the workhorse of most boats and automobiles. It has a long life, and can deliver enough amps to turn over a large diesel engine. Your battery should be covered and secured in a well-ventilated space to prevent fire or explosions. Five maintenance rules will prolong the life of your lead acid batteries.

1. Reduce or prevent deep-discharge cycles

Every time a lead acid battery is allowed to completely run down, it loses some of its longevity. The metal plates inside the battery area are called cells. These cells degenerate rapidly after the battery cycles (discharged and then recharged). After continuous cycling, the cells lose their ability to hold a charge.

2. Provide air circulation:

Explosive hydrogen gas is released when a battery is charging. This gas may ignite if not diluted with circulating air. Battery spaces should

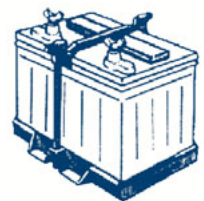

Hydrogen gas is released when a battery is charging

have constant air circulation to prevent explosions and fire. When working around batteries, it is important that there are no sparks from tools or electrical connections.

3. Maintain electrolyte fluids:

Fill your battery cells with distilled water when they get low. Tap water will introduce contaminants into the cells, and will reduce charging capacity.

4. Do not overcharge:

Charging your battery too fast, or for too long, will use up its fluid and the cells will become dry. When the cells dry, the battery will be irreversibly damaged. Use a proper charger for recharges, and monitor the amperage generated by your engines.

5. Keep the battery and its terminal clean:

Baking soda neutralises the acid that may be on your battery, or spilled around the battery tray. A damp cloth with baking soda will clean the surface and sides, while a wire brush can eliminate corrosion on the terminals.



3.6 Fuelling

All small craft should keep their fuel and oil tanks full. This helps vessel stability and reduces water accumulation in the fuel caused by condensation in the tanks. Having pressed up tanks will ensure a CCGA vessel is capable of response at all times. Auxiliary vessels should set a good example to the boating public by never running out of fuel.

3.6.1 Fuel Consumption and Range

Each crewmember should memorise the fuel consumption rate of the vessel at cruising speed and full out. This way everyone on board has a general sense of how much fuel has been consumed and the vessel's current range. This type of information can be extremely useful to a coxswain who is thinking about keeping the vessel on a safe course or responding effectively to an incident.

NOTE: Instrument warning:

Some modern vessels have consumption rate gages on the engine controls, where most vessels simply have fuel gauges. These instruments are notoriously unreliable and should be monitored but not trusted.



Know your vessel's fuel capacity/consumption and plan your trip accordingly.

Example: Canadian Coast Guard Auxiliary Vessel "Speedy Gonzales"

- ➔ Cruising RPM 2200
 - ➔ Approximate Speed at 2200 (20 knots)
 - ➔ Fuel consumption at 2200 (50 litres per hour)
 - ➔ Fuel Capacity 1000 litres
- Maximum Hours at Cruising speed $1000/50 = 20$ hours
 - 20 hours at 20 knots = 400 nautical miles (-20% safety margin)
 - Basic operating range at cruising speed 360 miles (180 miles out and 180 miles in)

3.6.2 Safe Fuelling

When taking on fuel at the dock, follow the steps outlined on the following checklist to prevent accidents and embarrassment. Coast Guard Auxiliary vessels must set an example at the fuel dock by demonstrating safe fuelling practices.

Steps to Safe Fuelling

- 1) Secure vessel to mooring.
- 2) Shut down engines.
- 3) Move portable tanks ashore.
- 4) Ensure all non-fuelling crew are ashore.
- 5) Extinguish all open flames prior to arrival.
- 6) Shut off main power.
- 7) Shut off bilge pump power.
- 8) Place fire extinguisher on standby.
- 9) Close all doors and windows.
- 10) Plug drain ports and scuppers.
- 11) Use the correct oil.
- 12) Ground nozzle against the fill pipe before fuelling.
- 13) Fuel slowly to prevent spillage.
- 14) Wipe up any spillage.
- 15) Check for vapours or odours.
- 16) Operate bilge blower for 2-4 minutes before starting engine.
- 17) Turn bilge pump back to auto.
- 18) Avoid over-filling expansion.